

Unicla® eDrive™

UD150 48 V dc

Part number	UD150
Motor series	Model 150 (48 V dc)
Refrigerant application	Low pressure
Motor speed range	800-1850 rpm
Optimal operating speed	1850 rpm
Displacement	145cc / rev
Number of cylinders	10
Nominal weight	21 kg
Max pressure	LP 7 bar // HP 25 bar
Relief valve	32 bar
Suction connection size	7/8 - 14 UNF #10
Discharge connection size	3/4 - 16 UNF #8

Connection pattern



Oil return fitting	7/16-20 UNF male flare
Oil type	PAG56 (Unidap 7)
Oil fill (factory)	200cc
Operating voltage	42-54 V dc
Current	62.5 A
Power	3000 W

Maximum operating ambient temperature (with ambient air flow) 45 °C

Maximum operating ambient temperature (with additional air flow) 55 °C

Enclosure class (controller housing & motor/compressor) IP55/IP68

Power supply gland Nickle plate M20x1.5

Electical certification date 16/10/2021

Communication & control interfaces CAN, RS485, USB, Ethernet, Bluetooth, 0-10 V dc, 4-20 mA, Run/Stop

Nominal dimensions L x W x H (mm) 451 x 161 x 237

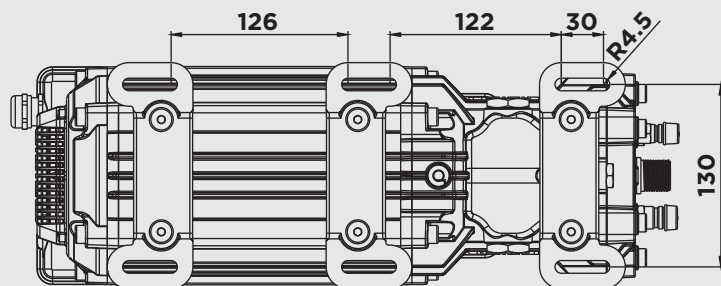

Bottom view

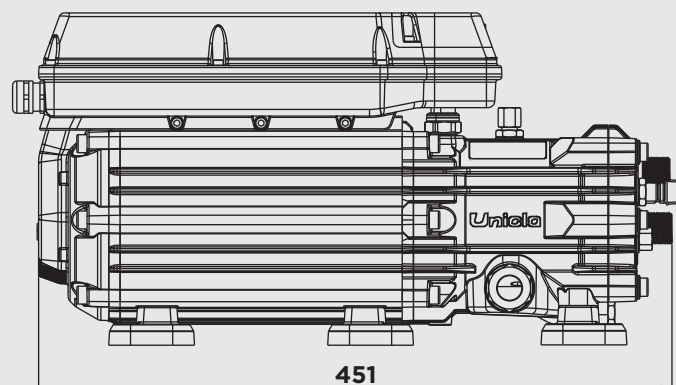

Side view

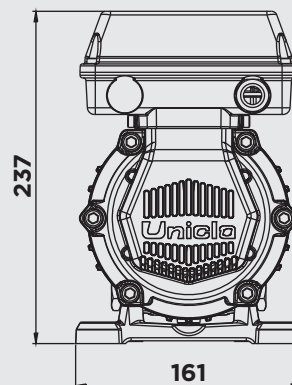

Front view





Scan the QR code
or visit www.unicla.hk
for more information
and technical support

Unicla International Limited
Unit 1109, 11/F, Manhattan Centre,
8 Kwai Cheong Road,
Kwai Chung, N.T., Hong Kong
PHONE: +852 2422 0180
FAX: +852 2422 0680
EMAIL: sales@unicla.hk

Unicla Australia
14 Motorway Circuit Ormeau,
Queensland 4208 Australia
PHONE: +61 7 5549 4033
FAX: +61 7 5549 4044
EMAIL: sales@unicla.hk

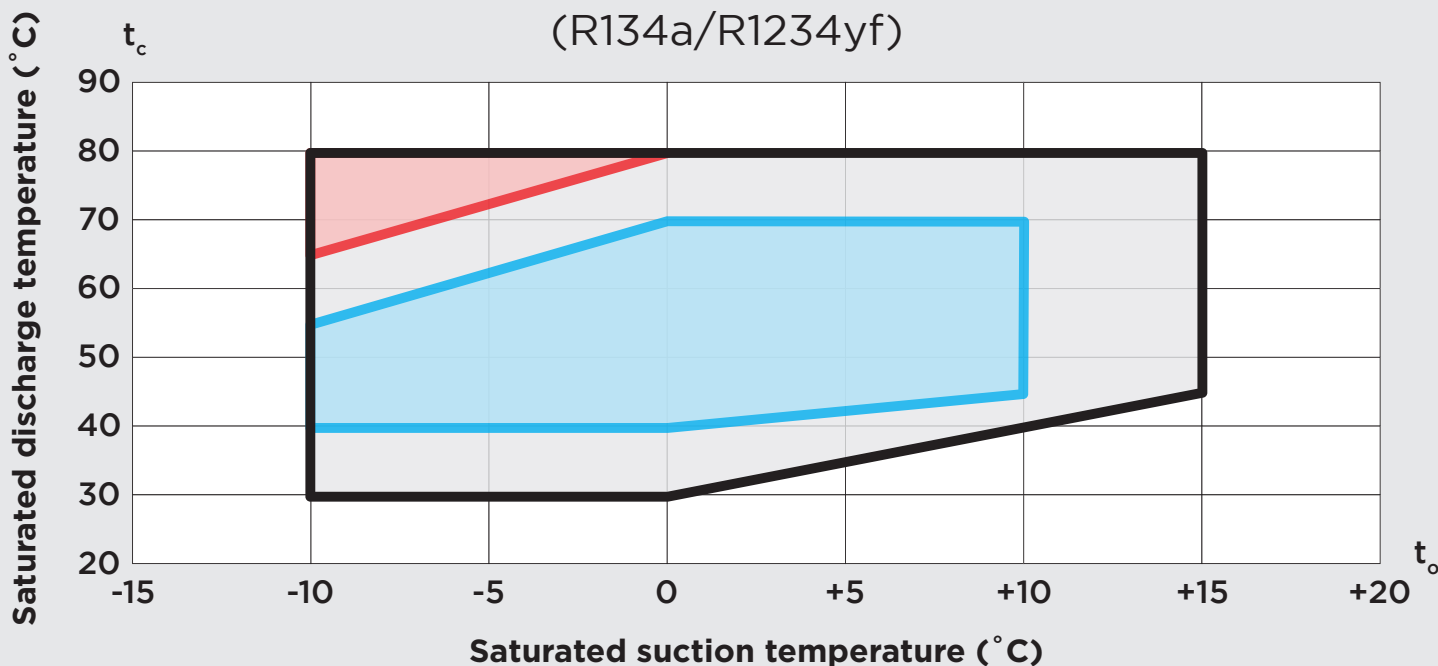
Operational limits (R134a/R1234yf)

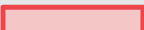

-  Operational limit
-  Ideal operation
-  Operation with maximum 20K superheat at suction

t_c = Condensing temperature
 t_o = Evaporating temperature

R134a

Model	Cond. T	Evap. T			kW
		-5	0	5	
UD150	35	6.2	7.6	9.7	Ca.
		2.1	2.4	2.6	PC
	45	5.0	6.2	8.0	Ca.
		2.4	2.6	2.8	PC
	55	4.0	5.2	6.6	Ca.
		2.5	2.7	3.0	PC

R1234yf

Model	Cond. T	Evap. T			kW
		-5	0	5	
UD150	35	5.9	7.2	9.2	Ca.
		2.0	2.3	2.4	PC
	45	4.6	5.4	7.4	Ca.
		2.1	2.2	2.5	PC
	55	3.6	4.7	5.9	Ca.
		2.2	2.3	2.6	PC

Unicla® eConnect™

A two-way conversation. At last.

Harness the true power of eDrive with eConnect, the interface between man and machine. eConnect is a multi-platform digital suite that communicates directly with eDrive, providing a wealth of data and information.

